



BENDER
CONNECT

LINETRAXX® CEP410R-2

AC and pulsed DC sensitive residual current monitor
at the central earthing point (CEP)



Table of contents

1	General information.....	5
1.1	How to use the manual.....	5
1.2	Indication of important instructions and information.....	5
1.3	Service and Support.....	5
1.4	Training courses and seminars.....	5
1.5	Delivery conditions.....	5
1.6	Inspection, transport and storage.....	6
1.7	Warranty and liability.....	6
1.8	Disposal of Bender devices.....	6
1.9	Safety.....	7
2	Function.....	8
2.1	Intended use.....	8
2.2	Device features.....	8
2.3	Start-up behaviour.....	8
2.4	Write access.....	9
2.5	Connection monitoring.....	9
2.6	Alarm assignments to the alarm relay.....	9
2.7	Delay times t_b , t , t_{on} and t_{off}	9
2.8	Combined function button (T/R button).....	10
2.9	Manual self test.....	11
2.10	Fault memory.....	11
2.11	Response value monitoring with prewarning and main alarm.....	11
2.12	NFC interface.....	12
2.13	Reset device to factory settings.....	12
2.14	Software update.....	12
3	Dimensions, mounting and connection.....	13
3.1	Dimension diagrams.....	13
3.2	Mounting and removal.....	14
3.3	Connection.....	14
3.3.1	Connections overview.....	14
3.3.2	Wiring diagrams.....	15
3.3.3	Supply voltage U_S	16
3.3.4	Measuring current transformer connection.....	16
3.3.5	RS-485 interface.....	17

4	Operation and settings on the device.....	18
4.1	Control panel.....	18
4.2	Overview of the display menu.....	18
4.3	Settings.....	19
4.3.1	Measuring points.....	19
4.4	STATUS LED.....	19
4.5	ALARM LEDs.....	19
4.6	VALUE DISPLAY LEDs.....	20
4.7	T/R BUTTON.....	20
4.8	Potentiometer.....	22
4.8.1	Potentiometer residual operating current.....	22
4.8.2	Potentiometer response delay.....	23
5	Modbus interface.....	24
5.1	Device information registers.....	25
5.2	Status information registers.....	26
5.3	Modbus-parameter registers.....	27
5.4	Device parameter registers.....	27
5.5	Device error codes registers.....	28
5.6	Function-control-commands registers.....	29
6	Error – Cause – Error correction.....	31
7	Technical data.....	32
7.1	Tabular data.....	32
7.2	Approvals.....	36
7.3	Ordering information.....	37

1 General information

1.1 How to use the manual



ADVICE

This manual is intended for qualified personnel working in electrical engineering and electronics! Part of the device documentation in addition to this manual is the enclosed supplement "Safety instructions for Bender products".



ADVICE

Read the operating manual before mounting, connecting and commissioning the device. Keep the manual within easy reach for future reference.

1.2 Indication of important instructions and information



DANGER

Indicates a high risk of danger that will result in death or serious injury if not avoided.



WARNING

Indicates a medium risk of danger that can lead to death or serious injury if not avoided.



CAUTION

Indicates a low-level risk that can result in minor or moderate injury or damage to property if not avoided.



ADVICE

Indicates important facts that do not result in immediate injuries. They can lead to malfunctions if the device is handled incorrectly.



Information can help to optimise the use of the product.

1.3 Service and Support

Information and contact details about customer service, repair service or field service for Bender devices are available on the following website: <https://www.bender.de/en/service-support>.

1.4 Training courses and seminars

Regular face-to-face or online seminars for customers and other interested parties:

<https://www.bender.de/en/know-how/seminars>

1.5 Delivery conditions

The conditions of sale and delivery set out by Bender GmbH & Co. KG apply. These can be obtained in printed or electronic format.

1.6 Inspection, transport and storage

Check the shipping and device packaging for transport damage and scope of delivery. In the event of complaints, the company must be notified immediately. Please use the contact form at the following address: <https://www.bender.de/en/service-support/take-back-of-old-devices/>.

When storing the devices, observe the information under Environment / EMC in the technical data.

1.7 Warranty and liability

Warranty and liability claims for personal injury and property damage are excluded in the case of:

- improper use of the device
- incorrect mounting, commissioning, operation and maintenance of the device
- Failure to observe the instructions in this operating manual regarding transport, commissioning, operation and maintenance of the device
- unauthorised changes to the device made by parties other than the manufacturer
- non-observance of technical data
- Repairs carried out incorrectly
- the use of accessories or spare parts that are not provided, approved or recommended by the manufacturer
- Catastrophes caused by external influences and force majeure
- Mounting and installation with device combinations not approved or recommended by the manufacturer

This operating manual and the enclosed safety instructions must be observed by all persons working with the device. Furthermore, the rules and regulations that apply for accident prevention at the place of use must be observed.

1.8 Disposal of Bender devices

Abide by the national regulations and laws governing the disposal of this device.



Bender GmbH & Co. KG is registered in the waste from electrical and electronic equipment (WEEE) register under the WEEE number: DE 43 124 402. For more information on the disposal of Bender devices, refer to <https://www.bender.de/en/service-support/take-back-of-old-devices/>

1.9 Safety

If the device is used outside the Federal Republic of Germany, the applicable local standards and regulations must be complied with. In Europe, the European standard EN 50110 applies.



DANGER

Risk of fatal injury due to electric shock!

Touching live parts of the system carries the risk of:

- *Electrocution due to electric shock*
- *Damage to the electrical installation*
- *Destruction of the device*

Before installing the device and before working on its connections, make sure that the installation is de-energised.

Observe the rules for working on electrical systems.

2 Function

2.1 Intended use

The device CEP410R-2 is intended for use in conjunction with the specified measuring current transformers for AC and pulse current sensitive residual current measurement in accordance with DIN EN IEC 62020-1.

The scope of application is the monitoring of the central earthing point for the detection of PEN bridges and connections between two neutral conductors of two separate TN systems, whereby the measured value is recorded in accordance with its intended use in a range of $f = 42...70$ Hz.

The devices are designed for operation in control cabinets or in a similarly protected environment.

The specifications in this manual must be observed for proper operation. Any other or additional use is considered improper.

2.2 Device features

- Alternating and pulsing current sensitive residual current monitoring device according to DIN EN IEC 62020-1, Type A
- Root mean square measurement (RMS)
- Measuring range: 10 mA...30 A (42...70 Hz)
- Prewarning: 50...100 % of residual operating current
- Supply voltage DC 24 V or AC/DC 100...240 V
- LED-strip measured value display
- Adjustable response delay
- Alarm relay (designed as changeover contact)
- Non-fail-safe current/fail-safe current principle and fault memory behaviour selectable
- RS-485 with Modbus RTU
- Continuous CT-connection monitoring
- NFC interface for device parameter setting with the device energised or de-energised

2.3 Start-up behaviour

Device start-up

With the adjustable start-up delay time t , the start-up can be further delayed in addition to the recovery time.

Start with alarm

The "Start with alarm" function (alarm assignment) can be used to control the behaviour of the relay during start-up. If the function is activated, the relay behaves as if an alarm is present. The function is automatically deactivated after the start-up delay time t has elapsed and the relay returns to its initial position.

"Start with alarm" is automatically reactivated the next time the device is started.

Further information

Overview of "Delay times", page 9

Modbus register (start-up delay) 32116

Modbus register (start with alarm) 32200

2.4 Write access

The "Write access" function is used to determine whether device parameters can be changed or written.

If write access is enabled, device parameters can be changed. Otherwise, device parameters can only be read.

"Test", "Reset" and "Identify device" can always be performed.

Write access can only be **enabled** directly on the device using the "T/R" button.

Write access can be **disabled** via

- T/R button
- Modbus interface
- Bender Connect App

Further information

Enable/disable write access on the device T/R BUTTON

Modbus register (disable write access) 32007

2.5 Connection monitoring

The connections to the measuring current transformer are continuously monitored. In the event of a fault, the alarm relay switches and the status LED flashes yellow. After the fault has been eliminated, the alarm relay automatically switches back to its initial position and the status LED lights up green. When the fault memory is enabled, the alarm relay only switches back to its initial position when the T/R button is pressed 1...3 s. Until then the status LED flashes yellow.

2.6 Alarm assignments to the alarm relay

The alarm relay can be assigned the following functions via the device interface

- Test
- Prewarning
- Residual operating current $I_{\Delta n}$
- CT connection fault
- Device error

2.7 Delay times t_b , t , t_{on} and t_{off}

The times t_b , t , t_{on} and t_{off} described below delay the output of alarms via LEDs, relay and Modbus RTU.

Recovery time t_b

The recovery time is the time the device needs to be ready for measurement after the supply voltage U_S has been connected.

Start-up delay t

After the supply voltage U_S has been connected, the measuring function is delayed by the set time t plus the recovery time t_b .

Response delay t_{on}

If values exceed or fall below the defined residual-operating-current limits, the residual current monitor needs the response time t_{an} to output the alarm. A set response delay t_{on} is added to the device-specific operating time t_{ae} and delays signalling:

Response time $t_{an} = t_{ae} + t_{on}$

If the fault does not persist during the response delay, the alarm is not signalled.

Delay on release t_{off}

The delay on release t_{off} starts when, after triggering the alarm state, the measured value reaches the release value again. During t_{off} , the release value must not be exceeded again.

After t_{off} has elapsed, the device returns to its initial state.

i The delay on release is only active when fault memory is switched off.

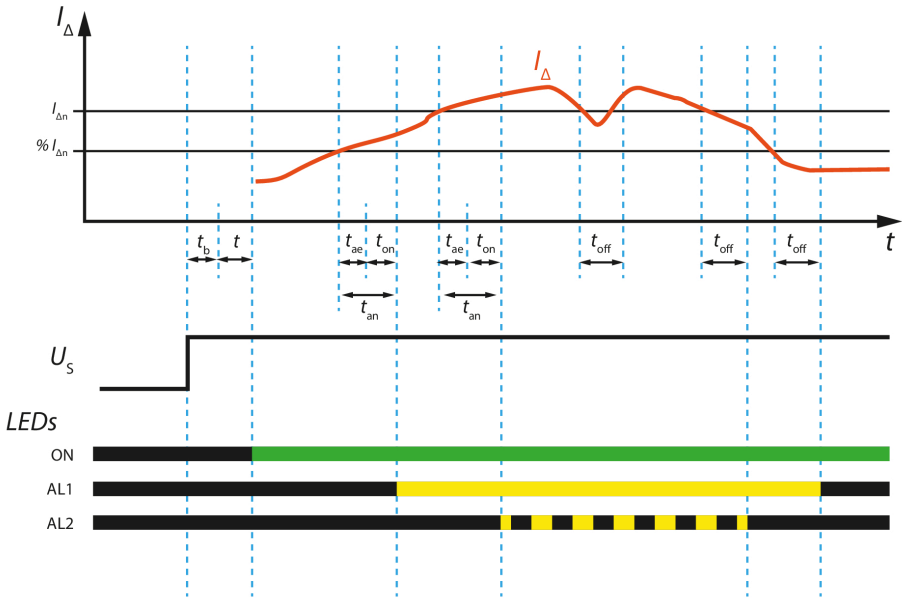

Figure 2-1: Time diagram delay times

2.8 Combined function button (T/R button)

Reset = pressing the T/R button 1...3 s

Test = pressing the T/R button 3...6 s

NFC = pressing the T/R button 6...10 s

Addr. = pressing the T/R button 10...15 s

Protect = pressing the T/R button 20...25 s

2.9 Manual self test

Pressing the T/R button (3...6 s) simulates an alarm condition. All LEDs light up and the output switches. If the fault memory is enabled, the alarm LEDs and the output remain active until the fault memory is cleared with a reset.



The manual self-test must be performed by the user periodically (at least every 6 months).

2.10 Fault memory

The fault memory can be enabled or disabled. When the fault memory is enabled, stored alarms are cleared with a reset. The fault memory is enabled in the factory setting.

2.11 Response value monitoring with prewarning and main alarm

The ZEP is measured using an external measuring current transformer. Triggering occurs based on the determined effective value.

If the set response value for $I_{\Delta n}$ (main alarm) is exceeded by a residual current, the response delay starts audibly. After the response delay has elapsed, the output relay K1 switches and the LED AL2 flashes.

If the relay alarm assignment for the prewarning is enabled (factory setting), relay K1 switches as soon as the threshold for the prewarning is exceeded and after the Response delay has elapsed. LED AL1 lights up.

If the relay's fault memory function is enabled, the device must be reset by pressing the T/R button (1...3 seconds = reset).

Measured value output

- The LED bar graph displays the relative measured value in relation to the set response value ($I_{\Delta n}$) in four stages: 0, 25, 50, 100%.
- The Modbus RTU interface outputs the measured value (register 1000) depending on the set response value. The measured value output is limited to 5 times the set response value ($5 \times I_{\Delta n}$). As soon as the measured value exceeds 5 times the set response value ($5 \times I_{\Delta n}$), a measurement range exceedance is displayed (register 3000).

The CEP410R-2 automatically checks the measuring current transformer and the function of the differential current measurement at regular intervals.

2.12 NFC interface



The NFC interface can be used to transmit a previously configured device parameter setting directly to the device.



This function is available only via the Bender Connect App. You can find this app in the Appstores for iOS and Android.



In the Bender Connect app the device first needs to be made known. Then the device-specific setting options are shown so that they can be configured. When the data is transferred, feedback is given whether the parameter configuration has been successful. Parameter settings can be transmitted to the device via the Bender Connect app by holding the mobile phone close to the device.



To a **de-energised** device, a parameter setting can be transferred via the Bender Connect app. This setting is then activated automatically when the device is connected to the current supply.



When a device is **plugged in**, too, parameters can be configured via the Bender Connect App. To this end, the NFC interface first needs to be activated in the device.

The NFC interface is activated via the T/R button at the front of the device or via the Modbus interface.

The NFC antenna is located at the front on the righthand side of the CEP410R-2.

2.13 Reset device to factory settings

The device can only be reset to its factory settings via the Modbus interface.

This function in the Modbus registers 60000...60003 offers two options:

- **Factory setting without interface parameters**
Resets all device parameters to the factory settings, except the Modbus interface parameters.
- **Factory setting with interface parameters**
Resets all device parameters to the factory settings.

Further information

Function 4: Reset to factory settings with/without interface parameters

2.14 Software update

After a software update, the device must first be reset to its factory setting. After that, all parameters can be adjusted again.

Further information

Allow software update via Modbus: 32006

Reset to factory settings via Modbus: **Function 4: Reset to factory settings with/without interface parameters**

3 Dimensions, mounting and connection



Only skilled persons are permitted to carry out the work necessary to install, put into service and run a device or system.



DANGER

Risk of fatal injury due to electric shock!

Touching live parts of the system carries the risk of:

- Risk of electrocution due to electric shock
- Damage to the electrical installation
- Destruction of the device

Before installing the device and before working on its connections, make sure that the installation has been de-energised. The rules for working on electrical systems must be observed.

3.1 Dimension diagrams

Dimensions in mm

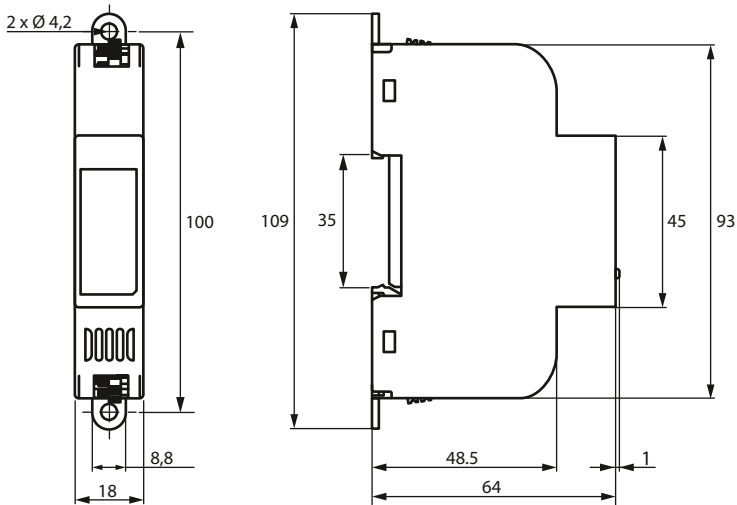

3.2 Mounting and removal

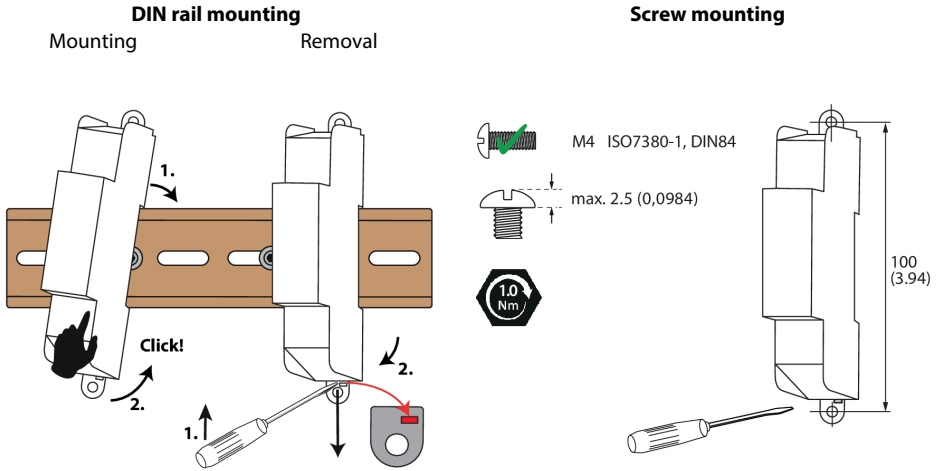

3.3 Connection

3.3.1 Connections overview

		Terminal	Connection
Top		A1, A2 S1, S2	Supply voltage U_S Measuring current transformer
Bottom		+	DC 24 V
		-	
		A	RS-485 A - Modbus RTU
		B	RS-485 B - Modbus RTU
		11, 14, 12	Alarm relay K1

The cables are connected to the device via push-in terminals. The maximum permissible conductor cross section is 1.5 mm².



CAUTION

Short circuit.

When finely stranded cables are inserted directly into the push-in terminals, spliced wires can cause a short circuit. Use ferrules.

The terminals only allow the use of ferrules from 0.25 mm² to 1.5 mm². The maximum cross section of 1.5 mm² should under no circumstances be exceeded!

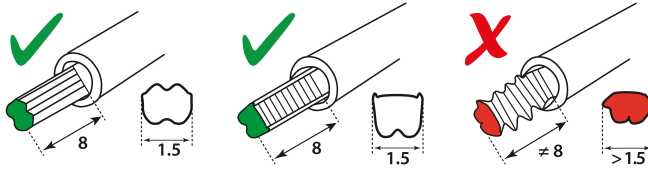

Use crimping pliers which

1. do not exceed the permitted crimp width of the ferrule and
2. do not leave strong crimp impressions on the ferrule.

i For cross-sections of 1 mm² or more, use suitable crimping pliers similar to models "CRIMPFOX 6", "Weidmüller PZ6" or "Weidmüller PZ6/5".

3.3.2 Wiring diagrams

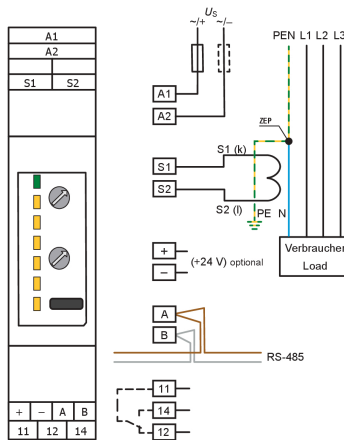

3.3.3 Supply voltage U_S

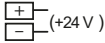

The device can be operated with a voltage of DC +24 V. The connection is made on the **bottom** of the device.

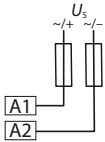

The CEP410R-2 is alternatively operated via connections A1 and A2 with a voltage of AC/DC 100–240 V. The connection is made on the **upper** side of the device.



CAUTION

Improper connection of the supply voltage

Irreparable damage to the device

Incorrect connection of the supply voltage (AC 230 V to DC 24 V connection) will destroy the device.

Ensure that the connection is correct!



ADVICE

Only one of the two supply voltages may be connected!



*When connecting the device to an **unearthed mains supply**, **two backup fuses** must be used. In **earthed mains supplies**, **at least one backup fuse** must be used.*

Recommended backup fuse: 6 A fast-acting

3.3.4 Measuring current transformer connection

CEP410R-2

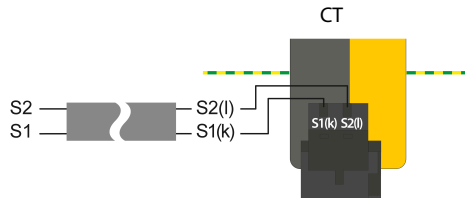
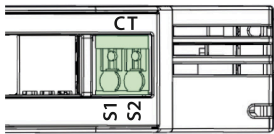

Ensure that the measuring current transformers are connected correctly. Terminal S1 must be connected to terminal "S1" (k) of the measuring current transformer. Terminal S2 must be connected to terminal "S2" (l) of the measuring current transformer.

The set response value must match the measuring current transformer. For further information on the connection of measuring current transformers, refer to the corresponding manuals of the measuring current transformers. The installation instructions specified there must be observed.



ADVICE

In the event of a short circuit, high currents can flow through the central earthing point. Observe the technical data in the manual for the measuring current transformer used.

Suitable measuring current transformers

CTAC series	CTAS series	W series	WR series	WS series
CTAC20	CTAS50	W10/600	WR70x175S	WS20x30
CTAC35	CTAS80	W0-S20	WR115x305S	WS50x80
CTAC60	CTAS120	W1-S35	WR150x350S	WS80x120
CTAC120		W2-S70	WR200x500S	WS50x80S
CTAC210		W3-S105	WR70x175SP	WS80x80S
		W4-S140	WR115x305SP	WS80x120S
		W5-S210	WR150x350SP	WS80x160S
			WR200x500SP	

3.3.5 RS-485 interface

Specification

The CEP410R-2 has an RS-485 interface with Modbus RTU protocol. In a system setup it is therefore compatible with other Modbus RTU-capable device series from Bender, such as e. g. the RCMB300 series, RCMS150-01, and RCMB13...-01.

Up to 247 Modbus-RTU devices can be used on the bus.

The RS-485 specification restricts the cable length to 1200 m and requires a daisy chain connection.

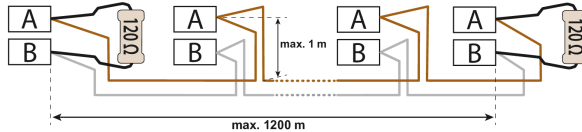

A twisted-pair, shielded cable must be used as bus cable. For example, cable type J-Y(St)Y n x 2 x 0.8 mm² is suitable. The shield must be connected to PE at one end.



If there are more than 16 bus devices, the interface must be designed to be shockproof, because the maximum permissible total leakage current of 0.5 mA is exceeded.

Termination

The bus cable must be terminated at both ends with resistors (120 Ω, > 0.25 W).

The terminating resistors are connected in parallel to the terminals A and B.

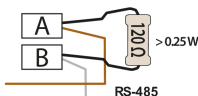

4 Operation and settings on the device

4.1 Control panel

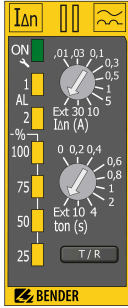

Control panel	Meaning
ON/🔧	STATUS LED Operating mode
AL1	ALARM LED Prewarning
AL2	ALARM LED Main alarm
25, 50, 75, 100 %	VALUE DISPLAY LEDs Residual current $I_{\Delta n}$
IΔn (A)	POTENTIOMETER 1 – Residual operating current $I_{\Delta n}$
ton (s)	POTENTIOMETER 2 – Response delay t_{on}
T/R	Test/reset button

4.2 Overview of the display menu

The menu button is used to access the device menu. The following items can be set or read out directly on the device. All other settings are only set or read out via Modbus.

Details follow in the next few paragraphs.

4.3 Settings

4.3.1 Measuring points

4.4 STATUS LED

Multicoloured display of various operating modes.



LED	Operating mode
Green	START PHASE Device booting after start NORMAL OPERATION Device in fault-free state
Yellow, flashing	CT FAULT Connection fault measuring current transformer
Yellow	DEVICE ERROR reversible Troubleshooting required.
Red	DEVICE ERROR irreversible Device replacement required.
Blue, flashing (frequency approx. 2 s)	NFC ACTIVE

4.5 ALARM LEDs

Display of prewarning AL1 and main alarm AL2

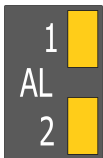

LED	Operating state
AL1	PRE-WARNING Lights up continuously when the prewarning threshold has been exceeded.
AL2	MAIN ALARM Flashes when the residual-operating-current threshold $I_{\Delta n}$ has been exceeded.

4.6 VALUE DISPLAY LEDs

Display of the measured value as a percentage of the residual operating current $I_{\Delta n}$ (incl. relative uncertainty)

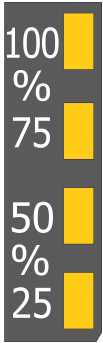

LED	Operating state
100	Lights permanently when the present measured value is > 100 % of $I_{\Delta n}$
75	Lights permanently when the present measured value is > 75 % of $I_{\Delta n}$
50	Lights permanently when the present measured value is > 50 % of $I_{\Delta n}$
25	Lights permanently when the present measured value is > 25 % of $I_{\Delta n}$

4.7 T/R BUTTON

The T/R button activates different operating modes depending on how long it is pressed.



Mode	Operating time	STATUS LED
RESET	1...3 s	flashes yellow
TEST	3...6 s	flashes red
NFC	6...10 s	flashes blue
ADDR	10...15 s	flashes green
PROTECT	20...25 s	flashes violet

Overview



"RESET" function

The "RESET" function on the button resets stored alarm states.

"TEST" function

The "TEST" function simulates a residual current of $1.5 \times I_{\Delta n}$ for a period of 5 seconds. During this period, the device has the following states:

- Display of the alarm value via the LEDs and the interface.
- The test status can be read out via the interface:

- 0 = no test
 - 1 = internal test
 - 2 = external test (interface)
- For the duration of the test t_{on} and t_{off} are set to 0 s.

"NFC" function

The "NFC" function changes the current activation status of the NFC interface, when the T/R button is pressed and held for a period of 6...10 s. The NFC interface disables automatically within 5 minutes, in case it has not been disabled manually before.

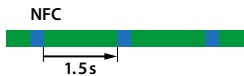

Status indication of normal operation with the NFC interface activated

"ADDR" function

The "ADDR" function switches the device to address setting mode for the RS-485 address. The channel indication LEDs and the status LED indicate the device's address.

How to enter an address:

1. Press and hold the T/R button until status LED flashes green (10...15 s).
– After the T/R button is released, the status LED lights red.
2. Set HUNDREDS digit. Press T/R button briefly until the desired value appears. Press and hold T/R button once (> 2 s) to confirm.
– After the T/R button is released, the status LED lights green.
3. Set TENS digit. Press T/R button briefly until the desired value appears. Press and hold T/R button once (> 2 s) to confirm.
– After the T/R button is released, the status LED lights blue.
4. Set UNITS digit. Press T/R button briefly until the desired value appears. Press and hold T/R button once (> 2 s) to confirm.
5. To exit the address setting mode, press and hold T/R button once (2 s).
– After the T/R button is released, the status LED lights green.

The address values are displayed via BCD code.

Addresses can only be entered within the valid address range. When there is no input for a period of 5 minutes, the device automatically exits the address setting mode. The device then uses the currently set Modbus address.

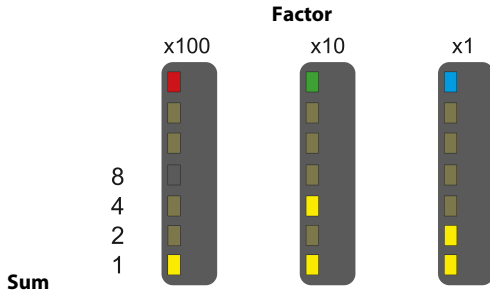

Current address: 153

"PROTECT" function

The "PROTECT" function on the T/R button locks or enables write access to the Modbus registers of the individual parameters. Modbus register 32007 "Write access" can only lock write access but cannot enable it.

- When the T/R button is activated for at least 20 seconds, the status LED changes from continuously green to flashing violet and remains like this for the next 5 seconds when the button continues to be pressed.
- When the T/R button is released while the status LED is flashing violet, the activation state of the Modbus register " Write access" switches from the current selection of the two possible states to the other state, i. e. from "enabled" to "locked" or vice versa.

4.8 Potentiometer

The residual operating current $I_{\Delta n}$ and the response delay time can be set directly on the device using the potentiometers. A value set on the potentiometer is always effective.

A value can only be set via Modbus in the **Ext** position. A value set via Modbus remains temporarily stored in the Modbus register when the potentiometer is adjusted and is reloaded when the **Ext** position is selected again.

As soon as one of the two potentiometers is adjusted, its position is displayed in binary code via the LEDs.

4.8.1 Potentiometer residual operating current

As soon as the potentiometer is adjusted, its position is displayed in binary code via the LEDs.



ADVICE

During commissioning and whenever a potentiometer is adjusted, check the correct potentiometer setting via the LED display.

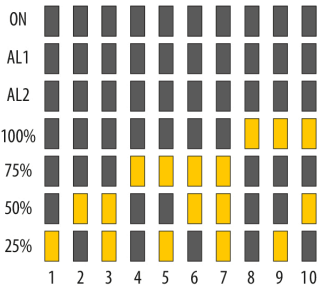
Setting potentiometer	Position	Binary LED display
	0.01 A	1
	0.03 A	2
	0.1 A	3
	0.3 A	4
	0.5 A	5
	1 A	6
	5 A	7
	10 A	8
	30 A	9
	Ext	10
		

4.8.2 Potentiometer response delay



ADVICE

During commissioning and whenever a potentiometer is adjusted, check the correct potentiometer setting via the LED display.

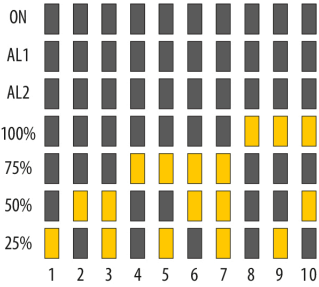
Setting potentiometer	Position	Binary LED display
	0 s	1
	0.2 s	2
	0.4 s	3
	0.6 s	4
	0.8 s	5
	1 s	6
	2 s	7
	4 s	8
	10 s	9
	Ext	10
		

5 Modbus interface

Overview

The following Modbus function codes are supported:

- Holding registers for reading out values (Read Holding Register; function code 0x03)
- Registers for device programming (Write Multiple Registers; function code 0x10)

For a complete Modbus-protocol specification, visit <http://www.modbus.org>.

Read and write permissions

RO	Read Only (read access only)
RW	Read/Write (read and write access)
WO	Write Only (write access only)

Data types

Float	IEEE754 32-Bit (single precision floating point number)	4 bytes
INT16	Signed 16-Bit Integer	2 bytes
INT32	Signed 32-Bit Integer	4 bytes
UINT8	Unsigned 8-Bit Integer	1 byte (shown as 2 bytes)
UINT16	Unsigned 16-Bit Integer	2 bytes
UINT32	Unsigned 32-Bit Integer	4 Bytes
String UTF8	ASCII character string	

Register ranges

Range	Start address	End address
Info	0	999
Status information	1000	6000
Modbus RTU parameters	32000	32010
Device parameters	32100	32199
Device error codes	58000	58999
Function-control commands	60000	60003

5.1 Device information registers

Device information (registers 0...998)

Register	Description	Format	Bytes	Property	Value/Unit/Comment
0	Device name	String UTF8	32	RO	CEP410R-2
16	Article number	String UTF8	32	RO	e.g.: B74603008
32	Serial number	String UTF8	32	RO	10 digits, e.g.: 2002123456
48	Manufacturer	String UTF8	32	RO	Bender GmbH & Co. KG
100	Application D number	UINT16	2	RO	642 = D642
101	Application version number	UINT16	2	RO	xxx = Vx.xx
102	Application build number	UINT16	2	RO	Build#
103	Boot loader D number	UINT16	2	RO	641 = D641
104	Bootloader version number	UINT16	2	RO	xxx = Vx.xx
105	Boot loader build number	UINT16	2	RO	Build#
106	Device status	UINT16	2	RO	Bit 0 (LSB): NFC - 0 = disabled, 1 = enabled Bit 1: Position potentiometer $I_{\Delta n}$ - 0 = not Ext, 1 = Ext Bit 2: Position potentiometer t_{on} - 0 = not Ext, 1 = Ext Bit 3...31: 0 (reserved)
108	Device properties	UINT32	4	RO	The following applies to all bit contents: 0 = no, 1 = yes Bit 0 (LSB): RCM for type B measuring current transformers Bit 1: Multi-channel RCM Bit 2: Digital inputs Bit 3: Digital outputs Bit 4: Measuring current transformer input configurable as digital input Bit 5: 1 relay available Bit 6: 2 relays available Bit 7: Filter settings available Bit 8: Winding ratio of measuring current transformer adjustable Bit 9...31: Reserved
110	Is the device switched on?	UINT16	1	RO	Register to determine whether the device is switched on. 0 = no, 1 = yes
111	Device version	String UTF8	29	RO	

5.2 Status information registers

Status information (registers 1000...6000)

Register	Description	Format	Bytes	Property	Value / Unit / Comment
1000	Residual current measured value	Float	4	RO	0...50 A
1004	Measured value block (maximum value)	UINT8	4	RO	<p>The maximum measured value with the corresponding alarm and measuring range status since the last Modbus query is output.</p> <p>Contents of the measured value block:</p> <ul style="list-style-type: none"> • Adr. Offset 0 (e.g. 1000): Measured value, part 1 [Float32] • Adr. Offset 1 (e.g. 1001): Measured value, part 2 [Float32] • Adr. Offset 2 (z. B. 1002): Alarm status with 0: no alarm 1: prewarning 2: main alarm 3: error • Adr. Offset 3 (e.g. 1003): Validity of the measured value with 0: „="“ 1: „<“ 2: „>“
1008	$I_{\Delta \max}$	Float	4	RO	Largest measured value since the last Modbus query
1010	$I_{\Delta \min}$	Float	4	RO	Smallest measured value since the last Modbus query
1012	$\varnothing I_{\Delta}$	Float	4	RO	Arithmetic mean value of the measured value since the last Modbus query
2000	Alarm status	UINT16	2	RO	0 = no alarm 1 = prewarning 2 = main alarm
3000	Measuring range status	UINT16	2	RO	0 = within measuring range 1 = below measuring range (not used) 2 = measuring range exceeded
4000	Test status	UINT16	2	RO	0 = no active test 1 = test active via T/R button, 2 = test active via interface
4001	Residual operating current set externally	UINT32	4	RO	Last residual operating current set via the interface [mA]
4003	Response delay set externally	UINT32	4	RO	Last response delay set via the interface [ms]
4005	Relay status	UINT16	2	RO	Current status of the output: 0 = Output inactive (no event of the alarm assignments has occurred) 1 = Output active (at least one event of the alarm assignments has occurred)
4006	Active state relay memory	UINT16	2	RO	The last active state (1) of the output is maintained until the next Modbus query
4007	Inactive state relay memory	UINT16	2	RO	The last inactive state (0) of the output is maintained until the next Modbus query

Register	Description	Format	Bytes	Property	Value / Unit / Comment
5000	CT status	UINT16	2	RO	0 = OK 1 = short circuit 2 = interruption

5.3 Modbus-parameter registers

Modbus RTU parameters (registers 32000...32010)

Register	Description	Format	Bytes	Property	Value/Unit/Comment	Factory setting
32000	Device address	UINT16	2	RW	1...247	Last 2 digits of the serial number + 100
32001	Baud rate	UINT32	4	RW	9600, 19200, 38400, 57600, 115200	19200
32003	Parity	UINT16	2	RW	1 = even 2 = odd 3 = none	1
32004	Stop bits	UINT16	2	RW	1 = 1 2 = 2 3 = automatic	3
32006	Allow update	UINT16	1	RW	1 = allow software update via Modbus RTU 2 = do not allow software update via Modbus RTU	2
32007	Write access	UINT16	1	RW	1: Enable write access (parameters can be changed) 2: Write access disabled (parameters can only be read)  ADVICE <i>Note: Access can only be enabled directly at the device via T/R button!</i>	1

5.4 Device parameter registers

Device parameters (registers 32100...32200)

Register	Description	Format	Bytes	Property	Value/Unit/Comment	Factory setting
32100	Alarm assignment test	UINT16	2	RW	1 = Enabled 2 = Disabled	1
32101	Operating mode	UINT16	2	RW	1 = Non-fail-safe 2 = Fail-safe	2
32102	Alarm assignment prewarning	UINT16	2	RW	1 = Enabled 2 = Disabled	2
32103	Alarm assignment main alarm	UINT16	2	RW	1 = Enabled 2 = Disabled	1

Register	Description	Format	Bytes	Property	Value/Unit/Comment	Factory setting
32104	Alarm assignment CT connection fault	UINT16	2	RW	1 = Enabled 2 = Disabled	1
32105	Alarm assignment device error	UINT16	2	RW	1 = Enabled 2 = Disabled	1
32106	Fault memory	UINT16	2	RW	1 = Enabled 2 = Disabled	1
32107	Residual operating current	UINT32	4	RW	10...30000 mA, step size1 mA Write Only possible if the potentiometer is set to Ext: Writes the parameter Read Reads the status (effective setting after evaluation of the potentiometer position)	30 mA
32109	Prewarning threshold	UINT16	2	RW	50...100 %, step size1 %	70 %
32110	Hysteresis	UINT16	2	RW	10...25 %, step size1 %	15 %
32111	CT connection monitoring	UINT16	2	RW	1 = Enabled 2 = Disabled	1
32112	Response delay	UINT32	4	RW	0...10000 ms, step size 1 ms Write Only possible if the potentiometer is set to Ext: Writes the parameter Read Reads the status (effective setting after evaluation of the potentiometer position)	0
32114	Delay on release	UINT32	4	RW	0...900000 ms, step size1 ms	0
32116	Start-up delay	UINT32	4	RW	0...900000 ms, step size1 ms	0
32200	Start with alarm	UINT32	4	RW	When enabled, the device behaves as if an alarm is present during device start-up. 1 = Enabled 2 = Disabled	1

5.5 Device error codes registers

Device error codes (58000...58999)

Register	Description	Format	Bytes	Property	Value / Unit / Comment
58000	Number of device errors	UINT16	2	RO	Number of active device errors
58001... 58009	Internal device error	UINT16	2	RO	Register content 0 = No error
58010	Connection fault measuring current transformer	UINT16	2	RO	Register content 0 = No error Register content 10 = Connect the CT correctly

5.6 Function-control-commands registers



Register 60000 (function-selection register) defines which function is enabled. Only specified values are permitted.

0 = Find device via serial number

1 = Set Modbus address

2 = Find device

4 = Reset to factory settings with/without interface parameters 6 = Start test

7 = Reset



The registers 60000...60003 must always be written as a block!

Function-control commands (60000)

Register	Description	Format	Bytes	Property	Value/Unit/Comment
Function 0: Find device via serial number					
60000	Function selection	UINT16	2	WO	0 = selection of the function "Find device via serial number"
60001	Serial number	UINT32	4	WO	Serial number of the device to be found
60003	Period	UINT16	2	WO	0...300 [s] = time until the corresponding device lights up; 0 = end search function
Function 1: Set Modbus address					
60000	Function selection	UINT16	2	WO	1 = Selection of the function "Set Modbus address"
60001	Serial number	UINT32	4	WO	Serial number of the device to be given a new Modbus address. Only the device with the corresponding serial number will accept the new Modbus address.
60003	Modbus address	UINT16	2	WO	0...247 = new Modbus address
Function 2: Find device					
60000	Function selection	UINT16	2	WO	2 = Selection of the "Find device" function
60001	Pattern value part 1	UINT16	2	WO	61918 Security pattern must be written for the function to be executed.
60002	Pattern value part 2	UINT16	2	WO	0 Security pattern must be written for the function to be executed.
60003	Period	UINT16	2	WO	0...300 [s] = time until the device lights up. When the device receives the value "0", the function is stopped.
Function 4: Reset to factory settings with/without interface parameters					
60000	Function selection	UINT16	2	WO	4 = Selection of the function "Reset to factory settings with/without interface parameters"
60001	Pattern value part 1	UINT16	2	WO	64199 Security pattern must be written for the function to be executed.
60002	Pattern value part 2	UINT16	2	WO	1304 Security pattern must be written for the function to be executed.

Register	Description	Format	Bytes	Prop-erty	Value/Unit/Comment
60003	Reset type	UINT16	2	WO	1 = Reset all parameters to the factory settings 2 = Reset to factory settings without interface parameters
Function 6: Start test					
60000	Function selection	UINT16	2	WO	6 = Selection of the function "Start test"
60001	Pattern value part 1	UINT16	2	WO	32343 Security pattern must be written for the function to be executed.
60002	Pattern value part 2	UINT16	2	WO	0 Security pattern must be written for the function to be executed.
60003	Type of test	UINT16	2	WO	3 = Start RCM test
Function 7: Reset					
60000	Function selection	UINT16	2	WO	7 = Selection of "Reset" function
60001	Pattern value part 1	UINT16	2	WO	13623 Security pattern must be written for the function to be executed.
60002	Pattern value part 2	UINT16	2	WO	0 Security pattern must be written for the function to be executed.
60003	Reset type	UINT16	2	WO	1 = Reset of the alarm message when fault memory is enabled

6 Error – Cause – Error correction

Error pattern	Cause	Correction
Complete device		
No device start	Terminal blocks incorrectly plugged in	Plug in terminal blocks correctly.
	Supply voltage incorrectly connected	Establish correct wiring.
RS-485		
Instable communication	Missing termination due to incorrect commissioning or defective component. No device is terminated.	Configure the terminating resistor, determine the terminating resistor value and replace it if necessary.
	Faulty termination due to incorrect commissioning or defective component. Either only one or more than two devices have been terminated.	Configure the terminating resistor, check quality of the bus signal.
No communication	Incorrect configuration: different baud rates between bus devices.	Calibrate baud rates between all bus devices.
	Incorrect connection: terminals A and B are interchanged.	Establish correct bus wiring.
Inputs and outputs		
No level change	Incorrect configuration: Output configured as input	Check configuration.
	Incorrect connection: external connections	Check configuration.
Alarm relays		
Relays do not energise	No alarm message due to defective component or defective controlling devices. No alarm source has been assigned.	Check relay for proper function, replace device if necessary. Assign alarm sources.
Relays do not de-energise	No alarm reset due to sticking or defective relay. Switching current > 5 A.	Replace device, if necessary. Observe technical data of the switching output.
	No switching of the relay due to excessive preloads on contacts.	Observe technical data of the switching output.
Enclosure		
Broken screw-mounting brackets	Device becomes detached due to broken mounting brackets.	Preventive measure: Use correct screw type and observe max. tightening torque. If the screw-mounting brackets are defective: mount on DIN rail or replace device.
Non-compliance with the insulation guideline	Insufficient insulation due to insufficient distance between mounting screws and connecting wires.	Use screws with plastic cover or mount on DIN rail.
Terminals		
Wires detach from the terminal	Due to splicing of wire ends, it is not possible to insert them into the terminal or fix them firmly in the terminal.	Use ferrules for mounting and connection to flexible cables.
Wires cannot be removed from terminal	Ferrules with strong crimp impressions get stuck in the terminal.	Use correct crimping pliers for mounting and connection with flexible cables.

7 Technical data

7.1 Tabular data

()* = Factory setting

Insulation coordination (IEC 60664-1/ IEC 60664-3)

Definitions

Supply circuit (IC1)	A1, A2
Output circuit (IC2)	11, 12, 14
Measuring & control circuit (IC3)	S1, S2, +, -, A, B
Rated voltage	250 V
Overvoltage category	III
Operating altitude	≤ 2000 m AMSL
Rated impulse voltage	
IC1/(IC2-3)	4 kV
IC2/IC3	4 kV
Rated insulation voltage	
IC1/(IC2-3)	250 V
IC2/IC3	250 V
Pollution degree	2
Protective separation (reinforced insulation) between	
IC1/(IC2-3)	300 V
IC2/IC3	300 V
Voltage test (routine test) acc. to IEC 61010-1	
IC1/(IC2-3)	AC 2.2 kV
IC2/IC3	AC 2.2 kV

Supply voltage

Connection	+, -
Supply voltage U_s	DC 24 V
Tolerance of U_s	-30...+25 %
Power consumption	≤ 2 W
Inrush current (< 5 ms)	< 10 A

Supply voltage

Connection	A1, A2
Supply voltage U_S	AC/DC 100...240 V (47...63 Hz)
Tolerance of U_S	$\pm 15\%$
Power consumption	$\leq 2\text{ W} / \leq 3.5\text{ VA}$
Inrush current (< 2 ms)	< 1.8 A

Measuring circuit

Burden (internal)	33 Ω
Frequency range	42...70 Hz
Measuring current transformer monitoring ¹⁾	On/off (on)*
Measuring range (peak)	2 mA...70 A
Measuring range rms	2 mA...50 A
Rated residual operating current	30 A
Response value main alarm $I_{\Delta n}^{1)}$	10 mA...30 A (30 mA)*
Prewarning ¹⁾	50...100% $\times I_{\Delta n}$ (70%)*
Operating uncertainty	$\pm 10\%$ (at 0.5...5 $\times I_{\Delta n}$)
Relative response uncertainty	6 mA...20 A: -20...0 % 20...30 A: -50...0 %
Rated thermal short-term current	2.4 kA/1 s
Hysteresis ¹⁾	10...25 % (15%)*
Fault-memory alarm messages	On/off (on)*

¹⁾ Can only be configured via RS-485

Measuring current transformers

Connection	CT (S1, S2)
Measuring-current transformer series, type A ¹⁾	CTAC..., CTAS..., W..., WR..., WS... series
CT connection monitoring	Yes
Rated voltage U_n	See technical data of the measuring current transformer
Rated surge current	6.0 kA/40 ms
Connecting cables	See technical data of the measuring current transformer
Cable lengths	

Single wire $\geq 0.75 \text{ mm}^2$	0...1 m
Single wire, twisted $\geq 0.75 \text{ mm}^2$	0...10 m
Shielded cable $\geq 0.75 \text{ mm}^2$	0...40 m

1) For a selection of suitable measuring current transformers, see chapter "Measuring current transformer connection", page 16

Time response

Start-up delay t	0...900 s (0 s)*
Response delay t_{on}	0...10 s (0 s)*
Delay on release t_{off}	0...900 s (0 s)*
Operating time t_{ae}	
with $1 \times I_{\Delta n}$	$\leq 260 \text{ ms}$
with $5 \times I_{\Delta n}$	40...120 ms
Response time t_{an}	$t_{an} = t_{ae} + t_{on}$
Recovery time t_b	$\leq 500 \text{ ms}$
Response time for CT connection monitoring	$\leq 10 \text{ s}$

Operation

Display	Status LED incl. LED bar graph
Display range, measured value	25 / 50 / 75 / 100 %
Button T/R	Reset / test / NFC / address setting

RS-485 interface

Connection	A, B
Protocol	Modbus RTU
Baud rate	Max. 115.2 kbits/s (19.2 kbits/s)*
Parity	even, no, odd (even)*
Stop bits	1/2/auto (auto)*
Cable length (at 9.6 kbits/s)	$\leq 1200 \text{ m}$
Recommended lines, shield on one side connected to PE	min. J-Y(St)Y 2 x 0.6 mm ² , twisted pair
Required terminating resistor	120 Ω (> 0.25 W)
Device address	1...247 (100 + last two digits of serial number)*

NFC interface

Frequency	13.56 MHz
Transmitting power (modulating; in 0 m distance, e.g.) ¹	0 W

- ¹
- EMC influences may lead to communication interruptions at the NFC interface.
 - The device does not transmit any radio waves when used as intended.

Switching elements

Relay	1 changeover contact
Connection	11, 12, 14
Operating principle	Fail-safe or Non-fail-safe (Fail-safe)*
Electrical endurance, number of cycles	10000

Contact data acc. to IEC 60947-5-1

Utilisation category	AC-13 / AC-14 / DC-12 / DC-12 / DC-12
Rated operational voltage	230 V / 230 V / 24 V / 110 V / 220 V
Rated operational current	5 A / 3 A / 1 A / 0.2 A / 0.1 A
Minimum contact load	
Relay manufacturer's reference (Refers to relays that have not been operated with high contact currents.)	1 mA at AC/DC ≥ 10 V

EMC/Environment

EMC	DIN EN IEC 62020-1
Operating temperature	-25...+55 °C
Transport	-40...+85 °C
Long-time storage	-40...+70 °C

Classification of climatic conditions acc. to IEC 60721

Stationary use (IEC 60721-3-3)	3K22
Transport (IEC 60721-3-2)	2K11
Long-term storage (IEC 60721-3-1)	1K22

Classification of mechanical conditions acc. to IEC 60721

Stationary use (IEC 60721-3-3)	3M11
Transport (IEC 60721-3-2)	2M4
Long-term storage (IEC 60721-3-1)	1M12

Connection

Terminals	Push-In
Connection properties	
rigid	0.2...1.5 mm ² (AWG 24...16)
flexible	0.2...1.5 mm ² (AWG 24...16)
with ferrule with plastic sleeve	0.25...0.75 mm ²
with ferrule without plastic sleeve (Use crimping pliers similar to CRIMPFOX 6 / Weidmüller PZ6/PZ6/5 only)	0.75...1.5 mm ²
Stripping length	8 mm

Other

Operating mode	Continuous operation
Mounting	Vertical
Degree of protection (DIN EN 60529)	
terminals	IP20
internal components	IP30
Enclosure material	Polycarbonate
DIN rail mounting acc. to	IEC 60715
Flammability class	UL94 V-0
Weight	≤ 100 g

7.2 Approvals

Standards & certifications

The CEP410R-2 device has been developed in accordance with the following standards:

- DIN EN IEC 62020-1



Licences

For a list of the open-source software used see our [Homepage](#).

Declaration regarding the radio system

EU declaration of conformity

Bender GmbH & Co. KG hereby declares that the device covered by the Radio Equipment Directive complies with Directive 2014/53/EU. The full text of the EU Declaration of Conformity is available at the following internet address:

[EU declaration of conformity CEP410R](#)

Hereby, Bender GmbH & Co. KG declares that this radio equipment complies with Radio Equipment Regulations 2017 (S.I. 2017/1206). The full text of the UK declaration of conformity is available at the following internet address:

[UKCA-Declaration of Conformity CEP410R](#)

7.3 Ordering information

Type	Supply voltage U_S	Measuring current transformers that can be used	Art. No.
		Type A	
CEP410R-2	DC 24 V AC/DC 100...240 V	X	B74603008

Accessories	Art. No.
Sealable transparent cover	B80609199

Date	Document version	Status/changes
08.2025	00	First edition
08.2025	01	<i>Corrected</i> Terminal label CT
02.2026	02	<i>Added</i> Message assignment "Start with alarm"



Bender GmbH & Co. KG

Londorfer Straße 65
35305 Grünberg
Germany

Tel.: +49 6401 807-0
info@bender.de
www.bender.de

All rights reserved.
Reprinting and duplicating only with
permission of the publisher.



© Bender GmbH & Co. KG, Germany
Subject to change!
The specified standards take into
account the edition valid until 02.2026
unless otherwise indicated.